



titan logix corp.

Creating Instrumentation Solutions - Everyday

Head Office

4130 – 93 Street
Edmonton, AB, Canada T6E 5P5
P (780) 462-4085
F (780) 450-8369

Saskatchewan Branch

Box 460, 103 Cenaiko Street
Lampman, SK, Canada S0C 1N0
P (306) 487-2883
F (306) 487-2889

© 2002-2008 Titan Logix Corp.



Manufactured in Canada

Toll Free 1-877-462-4085

Web Site www.titanlogix.com

E-Mail sales@titanlogix.com

Flo Pro 9100

Installation & Operation Manual



1000156MUI14
Rev. 14
Version 6.0



titan logix corp.

Creating Instrumentation Solutions - Everyday



Flo Pro 9100

WARRANTY STATEMENT

WARRANTY: Titan Logix Corp. warrants all equipment of its own manufacture to be free of defects in material and workmanship for a period of twelve (12) months from date of shipment. Titan Logix Corp. sole obligation hereunder shall be expressly limited to repair or exchange free of charge, F.O.B. Edmonton, Alberta, Canada, of such defective equipment (alternatively, Titan Logix Corp. will, at its option, refund the purchase price). Titan Logix Corp. obligation under this warranty is limited to the above and does not apply to exchange or repairs which are required as a result of improper installation, misuse, maladjustment, abnormal operating conditions, or lack of routine maintenance. Nor does the warranty include the furnishing of service for maintenance or problems arising from the foregoing causes. No claims for labour, installation, removal, transportation, or other expenses will be recognized. Notwithstanding any stipulation of the purchaser to the contrary, all other obligations, representations, warranties and conditions, express or implied, statutory or otherwise, including any implied warranties or conditions of merchantability, quality or fitness are hereby excluded and Titan Logix Corp. shall not be liable for any loss, cost or damages, of any kind whatsoever, whether consequential, indirect, special or otherwise, arising out of or in connection with the equipment or any defect therein, even if caused by the negligence of Titan Logix Corp., its employees or agents. The provisions hereof relating to the warranty and limitations hereon and limitation of liability shall continue to be enforceable between the parties notwithstanding termination of the within agreement for any reason including fundamental breach. Equipment not of Titan Logix Corp. manufacture will carry the vendor's or manufacturer's standard warranty.

CAUTION: WHEN THE FLO PRO 9100 IS USED IN CLASS 1 HAZARDOUS AREAS, USE ONLY A CSA APPROVED CLASS 1, DIV. 1 INTRINSICALLY SAFE BATTERY PACK MANUFACTURED BY TITAN LOGIX CORP. CONTACT YOUR DISTRIBUTOR FOR DETAILS

Table of Contents

1 Product Description	3
1.1 About This Manual	3
1.2 About the Flo Pro 9100	4
1.3 Main Features	4
2 Installation	5
2.1 Environmental	5
2.2 Outline	6
2.3 Layout	6
2.4 Turbine Meter Connection	7
2.5 Magnetic Pickup Sensitivity	9
2.6 Pulse Output Connection (optional feature)	9
2.7 Battery Packs	14
2.7.1 Low Battery Indication	14
2.7.2 Life Expectancy	15
2.7.3 Changing the Battery Pack	15
3 Operation	17
3.1 Display Definitions	18
3.2 First Time Power Up	18
3.3 Operation Modes	19
3.3.1 Active Mode	19
3.3.2 Power Save Mode	19
3.4 Displaying Accumulated Total and Flow Rate	19
3.4.1 Accumulated Total	19
3.4.2 Flow Rate	20
3.5 Resetting Accumulated Total	20
3.6 Programming	21
3.6.1 K Factor and Engineering Units	21
3.6.2 Volume Conversion Factors	23
3.6.3 10 Point Linearization Programming	24
3.6.4 Enabling 10 Point Linearization	25
3.6.5 Setting the Number of Points	25
3.6.6 Default K Factor	25
3.6.7 Linear Frequencies and Linear K Factors	26
3.6.8 Rate Update Interval	27
3.6.9 Accumulated Total Decimal Point Position	28
3.6.10 On Time (Active Time)	28
3.6.11 Accumulated Total Reset Enable	29
3.6.12 K Factored Pulse Output Multiplier (optional)	29
4 Troubleshooting	33
5 Specifications	34

© 2002-2008 Titan Logix Corp.

1 Product Description

1.1 About This Manual

This instruction manual provides information specific to the Titan Logix Corp. Flo Pro 9100. Other peripheral equipment should be supplied with its own instruction manual and that manual should be referred to for proper operation of the peripheral equipment.

This manual is for use with the Flo Pro 9100 Revision 14 or higher cards. Earlier Revisions of the Flo Pro 9100 use different circuitry which may not correlate with the information in this manual. For information on Revision 13 or earlier cards please contact your distributor or Titan Logix Corp..

It is essential that this manual be read and understood for proper installation and operation of your Flo Pro 9100.

This manual includes:

<i>INTRODUCTION:</i>	Briefly describes the key features of the Flo Pro 9100.
<i>INSTALLATION:</i>	Detailed description of mounting and wiring of external equipment, as well as the details about the battery packs.
<i>OPERATION:</i>	Describes the operation and use of the features of the Flo Pro 9100.
<i>PROGRAMMING:</i>	Describes the procedures for programming the Flo Pro 9100.
<i>TROUBLESHOOTING:</i>	Describes several quick problem solving techniques.
<i>SPECIFICATIONS:</i>	Describes the physical and operational characteristics.

1.2 About the Flo Pro 9100

The Flo Pro 9100 is an intrinsically safe flow totalizer and rate meter. The Flo Pro 9100 accepts input pulses from a turbine meter, and uses those pulses to calculate the flow total and rate in a pipeline. The Flo Pro 9100 displays the information on a built in, high contrast, LCD display. For connection to a standard RTU or PLC, the Flo Pro 9100 also has a prescaled or K factored pulse output (optional). For true stand alone operation the Flo Pro 9100 uses a 6V battery pack with a minimum life of 4 years.

These features combine to make the Flo Pro 9100 a versatile solution to flow measurement problems.

Please refer to the Installation section of this manual for directions on how to connect and set up the Flo Pro 9100.

1.3 Main Features

Enclosure:	NEMA 4, Fire Retardant Fiberglass
Input/Output:	Turbine input from 1Hz to 3.0kHz and 20mVpp minimum at 90Hz. Adjustable pulse input sensitivity for use in noisy environments. Flow total and rate displayed on high contrast LCD display. Prescalable or K factored pulse output for connection to standard RTU or PLC input. (optional)
Reliability:	Built using industrial specified components to ensure long life and reliability even in harsh conditions.
Programming:	The Flo Pro 9100 can be programmed by the operator. The programmable features are K Factor (0000001 to 9 999 999 with two decimal digits), Total decimal point position, Rate update interval (2 to 20 seconds), 10 point linearization parameters, Display on time (1 to 99 minutes), and accumulated total reset (enable or disable).
Optional Pulse Output:	A prescalable or "K" factored pulse output is an available option for connection to standard RTU or PLC input.

2 Installation

Installation should only be performed by qualified personnel, and in accordance with local governing regulations.

The Flo Pro can be mounted directly on top of the turbine as shown in figure on page 8 or it can be panel mounted using 4 polyester mounting brackets and stainless steel screws.

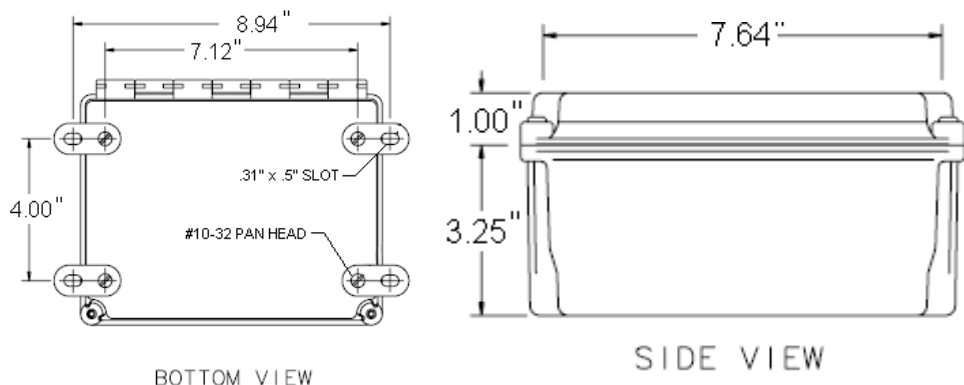

2.1 Environmental

Choose a mounting location suited to the Flo Pro 9100 enclosure.

The ideal Flo Pro 9100 mounting location is where the:

1. Turbine pickup is as close as possible.
2. Mounting surface has minimal vibration.
3. Ambient temperature is always within -40°C to $+65^{\circ}\text{C}$ (-40°F to $+149^{\circ}\text{F}$).
4. Cable lengths are minimal.

Avoid mounting locations where the Flo Pro 9100 is:

- Vibrating.
- Facing the sun directly for long periods of time (this could degrade the faceplate seal and void the NEMA 4 rating).
- Close to high voltage/current runs, contactors, SCR control devices, or frequency inverters.

2.2 Outline

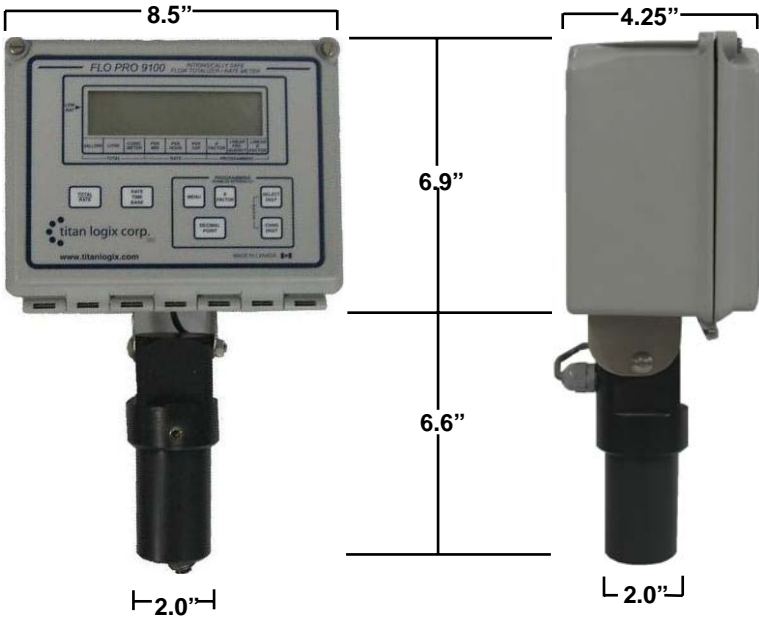

2.3 Layout

Please refer to the following diagram for the location of the configuration jumpers and the I/O terminals on the Flo Pro 9100.

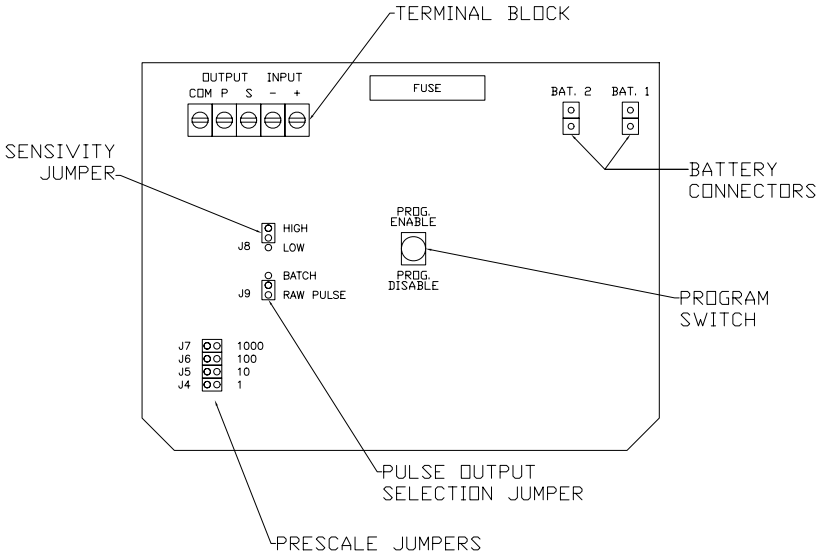

2.4 Turbine Meter Connection

To mount the Flo Pro 9100 and make the connection to the turbine meter, follow these steps (see the diagram on the following page):

1. Screw the bottom half of the 1" PVC pipe union onto the turbine meter threads.
2. Connect the Magnetic pickup to the connector inside the base of the Flo Pro 9100. **IT DOES NOT MATTER WHICH WAY THE CONNECTOR IS ATTACHED TO THE MAGNETIC PICKUP.**
3. Mount the Flo Pro 9100 on the union and tighten securely.

To adjust the position of the Flo Pro 9100, loosen the union to rotate the unit into the right position, and/or loosen the nut on the swivel base and adjust the viewing angle. *Be sure to tighten the union and the nut securely when adjustment is complete.*

The Flo Pro 9100 must be used with one of the following pickups.



Company	Part Number	
Smith Systems	005 225	
Blancett	111109	
Turbines Inc.	TA0004	
Electronic Data Devices	4.303	Type 1
	4.303	Type 2
	1.303	Type 3

After installation is complete, the flow total should be reset - even if the flow total on the LCD reads zero (see the Operation section of this manual). This ensures that all internal counters and buffers used to calculate the flow total are cleared as well as the flow total itself.



Extended exposure to bright sunlight could degrade the seal on the faceplate. To prevent this, ensure the unit is protected from extended exposure by a sunshade or, if no sunshade is available, facing the unit north.

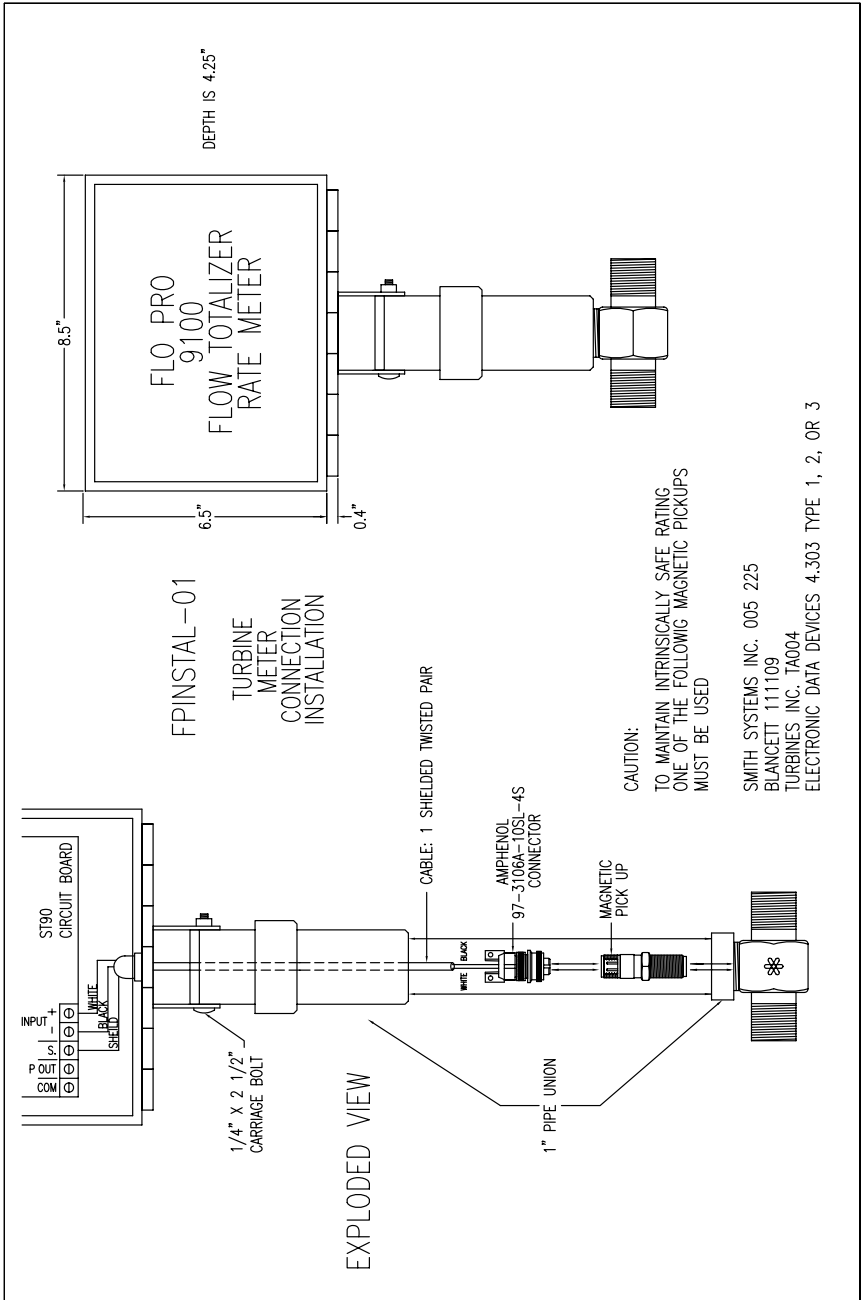

2.5 Magnetic Pickup Sensitivity

Two magnetic pickup sensitivity levels are provided and are selected by J8 as follows:

J8-A = high sensitivity (20mVp-p @ 90Hz), use for 3/8", 1/2" and 3/4" flow turbines.

J8-B = low sensitivity (120mVp-p @ 150Hz), use for 1" or larger flow turbines.

If the unit appears to be too sensitive, check that the proper input sensitivity has been selected for the flow meter being used (see above).

Note: The sensitivity has been preset at the factory to a level which is sufficient for most applications that the Flo Pro 9100 has been designed for.

Stray counts may be generated if the Flo Pro 9100 is not connected to a magnetic pickup. This is due to the high gain of the magnetic pickup circuitry. This is not a malfunction of the unit, and when installed as described in the installation section of this manual, the unit will calculate correct flow total and flow rate.

2.6 Pulse Output Connection (optional feature)

The Flo Pro 9100 provides a pulse output signal for connection to plant monitoring equipment. The Pulse Output may be configured through the Pulse Output Selection Jumper as either Raw Pulse or Batch. When set to Batch the Pulse Output will be K factored using the same value as the display (see the Programming section of this manual for setup of the K factored Pulse Output). When set to Raw Pulse the K factor will have no effect on the Pulse Output, however the raw pulses from the turbine may be divided by 10, 100, or 1000 through the Prescale Jumper.

Prescale Jumper Settings:

J4 = divide by 1, J5 = divide by 10, J6 = divide by 100, J7 = divide by 1000.

$$\text{PULSE OUTPUT} = \text{PULSE INPUT} / \text{PRESCALE SETTING}$$

Note: When using the K factored Pulse Output the Prescale Jumper must be set to divide by 1 or an incorrect Pulse Output will result.

To install the pulse out, refer to the following diagrams.



An electrical barrier must be used for the pulse output connection to plant equipment when used in hazardous locations

FPINSTAL-03
1/2" MYERS HUB INSTALLATION FOR PULSE OUTPUT

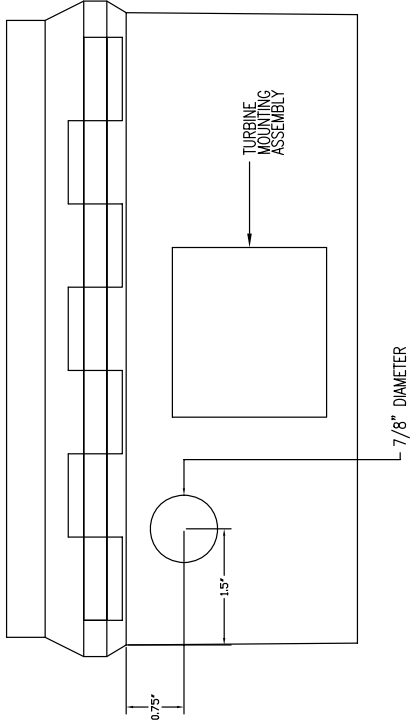

- NOTES:
- 1) PUNCH OR DRILL 7/8" HOLE AT THE LOCATION SPECIFIED.
 - 2) INSTALL 1/2" MYERS HUB.
 - 3) INSTALL 1/2" CONDUIT AND PIPE.
 - 4) REFER TO PULSE OUTPUT INSTALLATION/SCHEMATIC DIAGRAM FOR WIRE CONNECTIONS.
- BOTTOM VIEW OF CASE

FPINSTAL - 02
PULSE OUTPUT INSTALLATION

PULSE OUTPUT CONNECTION TO NON-ISOLATED D.I. POINT

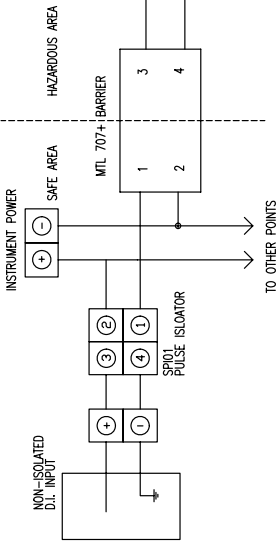

PULSE OUTPUT CONNECTION TO TYPICAL OPTO ISOLATED D.I. POINT

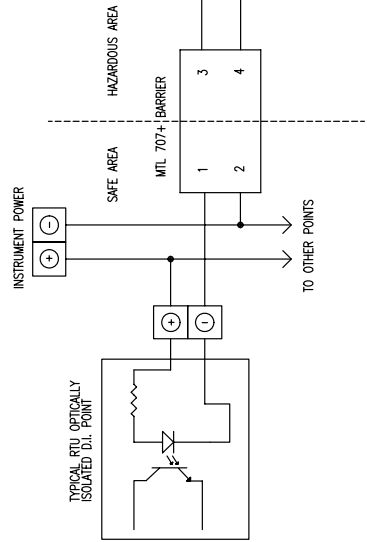

FPINSTAL-04
PULSE OUTPUT INSTALLATION

FLOPRO 9100 PULSE OUTPUT CONNECTION TO FISHER ROC PISRC MODULE

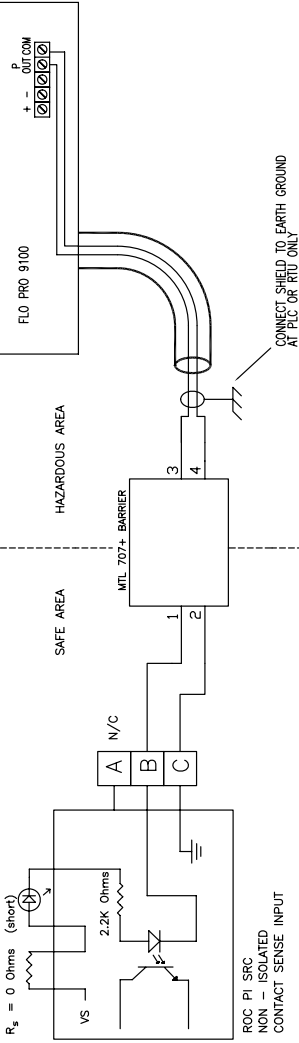

FLOPRO 9100 PULSE OUTPUT CONNECTION TO FISHER ROC PIISO MODULE

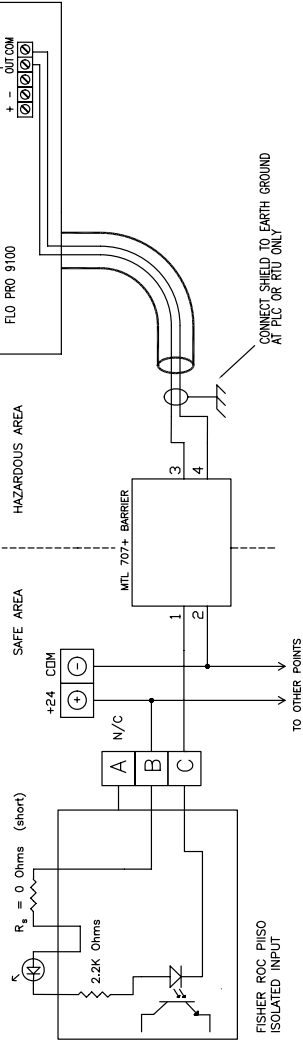

FPINSTAL - 05

PULSE OUTPUT INSTALLATION
FOR NON-HAZARDOUS AREA ONLY

PULSE OUTPUT CONNECTION TO NON-ISOLATED D.I. POINT

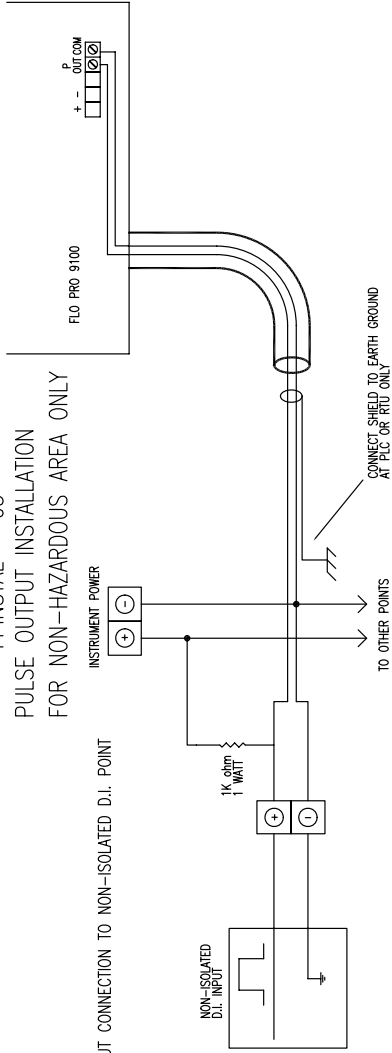

PULSE OUTPUT CONNECTION TO TYPICAL OPTO ISOLATED D.I. POINT

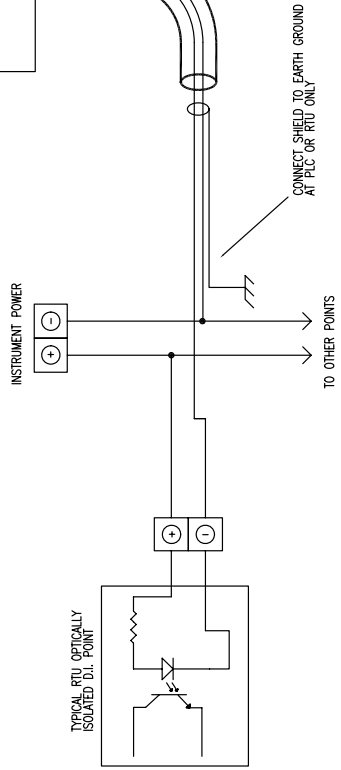

2.7 Battery Packs

CAUTION

When used in hazardous areas the Flo Pro 9100 may *only* be powered by the 6V battery pack manufactured by Titan Logix Corp.

2.7.1 Low Battery Indication

To ensure proper operation of the Flo Pro 9100 it is recommended that the battery pack be changed at the specified minimum life expectancy (before the low battery indicator comes on). The battery pack should provide significantly longer service, in most instances, than the minimum battery life specified with reasonable usage.

A low battery condition is indicated by the tag (!) on the left side of the display. To ensure correct operation, the battery pack should be changed as soon as possible. When there is a low battery condition, the Flo Pro 9100 will go into the power saving mode 20 seconds after the last key press. Once the low battery tag has come on, the unit has about one month of battery life left. If the battery is not changed within this time, a “CHng bAt” message is displayed and the unit is no longer operational.

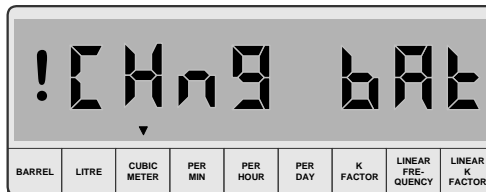

2.7.2 Life Expectancy

Battery Pack*	Comments / Application	Life Expectancy (not using 10 point linearization)	Life Expectancy (using 10 point linearization)
DPC-4S	Standard (Alkaline) Battery Pack Low cost, safe, easy disposal. Use for -40°C to +54°C operation.	4 yrs. Minimum	3 yrs. Minimum
BRC-2W	Standard Lithium Battery Pack Use for -20°C to +65°C operation.	4 yrs. Minimum	3 yrs. Minimum
BRC-4W	Long Life (Lithium) Battery Pack Use for -20°C to +65°C operation	5 yrs. Minimum	4 yrs. Minimum

Battery life expectancy is based on the On Time Parameter being set to 1 or 2 minutes.

Note: The Flo Pro 9100 has two battery inputs. It is possible to extend battery life by connecting a battery pack to each input. The two battery packs must be the same type.

2.7.3 Changing the Battery Pack

To change the battery pack, open the quick release clamps or unscrew the screws at the top corners of the unit and swing the case door downwards. Connect a new battery pack to the vacant battery input labeled BAT 1 or BAT 2. Remove the battery retaining bracket and disconnect and remove the old battery pack. Secure the new battery pack in place with the battery retaining bracket. Refer to the diagram on the following page.



* Only Titan Logix Corp. battery packs should be used. Please note: using a different battery will void the intrinsically safe feature and CSA approval.

BATTERY CHANGING DIAGRAM

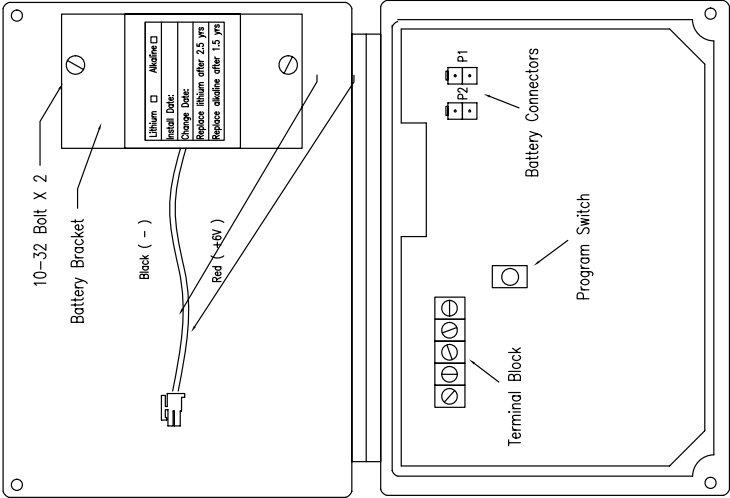

TO CHANGE BATTERY:

- 1) Undo front panel bolts and open case.
- 2) Loosen battery bracket by unscrewing 10-32 bolts.
- 3) Connect replacement battery to the unused battery terminal. (P1 or P2)
- 4) Disconnect dead battery pack from battery terminal and remove from battery bracket.
- 5) Install new battery pack.
- 6) Tighten 10-32 battery bracket bolts.

3 Operation

Please refer to the picture below for the locations of the keys and indicators referred to throughout the remainder of this manual.

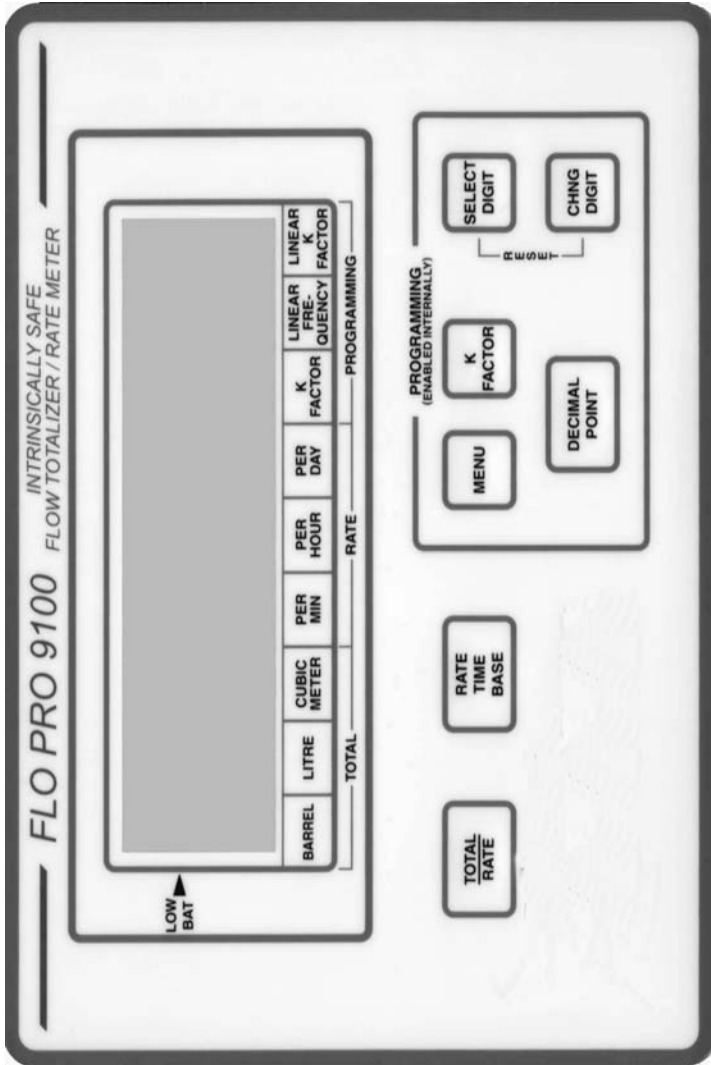

3.1 Display Definitions

- Total:** The total display shows the current number of accumulated counts up to eight digits. The engineering unit (Gallons, litre, or cubic meter) being measured is also displayed. Total is equal to the total accumulated raw counts divided by the K factor. A decimal point is provided for displaying total in 0.1, 0.01, and 0.001 units.
- Rate:** Rate displays the current flow rate in units, either per min, per hour, or per day. Rate is updated depending on the rate update setting.
- K Factor:** K factor is the number that is divided into the raw counts received from the turbine meter and the result is added to the number of accumulated counts. The default setting is 1.
- Rate Update:** Rate update is the time over which the input pulses are counted for calculating the flow rate. This allows the totalizer to calculate an average flow rate on slow or fluctuating flows. The rate period is adjustable from 2 to 20 seconds. The default setting is 2 seconds.

3.2 First Time Power Up

To power up the Flo Pro 9100 for the first time, connect the 6V battery pack to the connector labeled BAT 1 or BAT 2, located at the bottom left hand corner of the printed circuit board. At this point the unit executes a brief diagnostic test and defaults to the Accumulated Total display (should read 0, if not the total should be reset). The Flo Pro 9100 will remain active for the duration of the On Time.



The K Factor and engineering units *must* be programmed before the unit will operate correctly.

3.3 Operation Modes

3.3.1 Active Mode

Active Mode is entered by pressing any key on the face of the Flo Pro 9100. In Active Mode the Flo Pro 9100 calculates the Accumulated Total once per second and updates the display (if Accumulated Total display is selected). The Flow Rate is calculated and the display updated according to the Rate Update Interval (if Flow Rate display is selected). The Flo Pro 9100 will remain in the Active Mode for the duration of the On Time parameter. For example, if the On Time is set to 2 minutes, the unit will enter Power Save Mode 2 minutes after the last key press.

3.3.2 Power Save Mode

In Power Save Mode the unit calculates Accumulated Total once every 8 seconds. If the LCD display is left enabled during Power Save Mode the display will be updated every 8 seconds. If the LCD display is not enabled during power save mode the unit will remain blank until the unit is placed back into active mode by the operator. To engage active mode, press any key on the face of the Flo Pro. **THE ENABLING AND DISABLING OF THE LCD DISPLAY IS DONE IN THE PROGRAMMING SECTION OF THIS MANUAL UNDER: ON TIME (ACTIVE TIME).** When the Accumulated total is updated, the decimal point may blink momentarily. Only Accumulated Total can be displayed in Power Save Mode. **FLOW RATE IS NOT UPDATED IN THIS MODE.**

3.4 Displaying Accumulated Total and Flow Rate

3.4.1 Accumulated Total

Accumulated Total is displayed by pressing the TOTAL/RATE key. The TOTAL/RATE key will alternately display the current accumulated total or flow rate each time the key is pressed. When total is being displayed, one of the

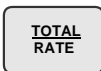

TOTAL indicator arrows will be on, pointing to the engineering units being measured, the RATE indicator arrows will all be off. The decimal point position for the total display may be changed by pressing the DECIMAL POINT key (see the Accumulated Total Decimal Point Position in the Programming section of this manual).

3.4.2 Flow Rate

Flow Rate is displayed by pressing the TOTAL/RATE key. The TOTAL/RATE key will alternately display flow rate or the current accumulated total each time the key is pressed. When rate is being displayed, one of the TOTAL indicator arrows

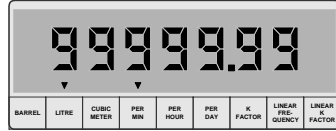

will be on and one of the RATE indicator arrows will be on, pointing to the rate time base (either PER MIN, PER HOUR, or PER DAY). When rate is being calculated the message "CALC" will be displayed on the LCD. The amount of



time for a rate calculation is determined by the rate update setting. The maximum flow rate is 99999.99 units/time. If the flow rate exceeds this amount an "O.F"



message will be displayed on the LCD display.

When Flow Rate is being displayed, the RATE TIME BASE key may be pressed



to change the rate time base from PER MIN, PER HOUR and PER DAY. Each time the RATE TIME BASE key is pressed, the rate is recalculated and is indicated by the "CALC" message on the LCD display.

3.5 Resetting Accumulated Total

If the unit has been programmed for resettable operation (p.33), the total accumulated counts may be reset by pressing the SELECT DIGIT and CHNG DIGIT key simultaneously for three seconds.



Chain of Custody Transfer

When using the Flo Pro for custody transfer (or where accumulated total is needed every second), it is recommended to disengage the LCD display while the Flo Pro is in Power Save Mode. An operator will then have to press one of the key pads to get a reading. Pressing one of the key pads will engage the LCD display and engage the active mode. The Flo Pro will provide one second updates for accumulated total when in active mode. The Flo Pro updates accumulated total every 8 seconds when in power save mode.

3.6 Programming

The Flo Pro 9100 has eight parameters that can be programmed, they are:

- K Factor
- 10 Point Linearization (compensation for nonlinear K Factor vs. Flow Rate)
- Rate Update Interval
- Accumulated Total Decimal Point Position
- On Time (Active Time) LCD display on/off
- Accumulated Total Reset Enable
- K factored Pulse Output Enable
- Pulse Output Multiplier (optional feature)

Programming of these parameters can only be done when the programming enable/disable switch (PROG) inside the unit is set to the Enable position. The only parameters that need to be programmed before putting the unit into service are the K factor and Engineering units. The other parameters will be set to a default value as indicated below.



Do not change the programmed parameters while the unit is in operation, as it may result in incorrect total flow and flow rate readings. It is recommended that the PROG switch be set to the disable position to secure programmed data.

3.6.1 K Factor and Engineering Units

K factor programming allows the Flo Pro 9100 to be set up so the total accumulated flow reading can be set to read in engineering units such as gallons, litres or cubic meters. This requires that the number of pulses from a turbine meter for one (1) unit of volume be known. For example, if a particular turbine meter produces 3885823 pulses per cubic meter, and it is required that the accumulated flow reads in cubic meters, the K factor should be set to 3885823. With this setting, the total will increment one count for every 3885823 pulses, giving a unit count of cubic meters. The K factor can be set to a maximum value of 9 999 999 with 2 decimal point positions (99999.99 maximum K factor when the 0.01 decimal point position selected).



The K factor for the turbine in use should be found on a tag on the turbine itself. The K factor used must represent a single unit of flow. A K factor of zero is illegal and if entered the K factor defaults to 0000001.

Engineering unit programming allows the Flo Pro 9100 to give a visual indication of the units being measured whether it be gallons, litres or cubic meters, and is for display purposes only. Changing this setting does not affect the total counts registered on the display.



Press the K FACTOR key to display the current K Factor and Engineering units. The indicator arrow above K FACTOR will be on as well as the indicator for the current engineering unit.

To begin programming the K Factor, Press the SELECT DIGIT key. All seven digits of the K Factor will appear on the display with the far right digit blinking to



indicate it is ready to be changed.

Press the CHNG DIGIT key to increment the flashing digit. Press the SELECT DIGIT key to advance to the next digit.

The K Factor decimal point position may be changed any time one of the K Factor digits is flashing by pressing the DECIMAL POINT key.

To change the Engineering Unit Indicator, press the SELECT DIGIT key until the indicator arrow is flashing. Press the CHNG DIGIT key to cycle the indicator through the available units.



Note: The engineering unit indicator is a visual indication only, it will not adjust any calculations. **TO MAKE THE FLO PRO 9100 MEASURE IN THE UNITS INDICATED, THE K FACTOR MUST BE ADJUSTED.**

3.6.2 Volume Conversion Factors

The following volume conversion factors are provided to aid in calculating the correct K factor from one flow unit to the other.

1 US gallon	= 0.0037854 cubic meters
1 US gallon	= 3.78541 litres
1 cubic meter	= 264.17205 US gallons
1 cubic meter	= 6.28981 barrels
1 cubic meter	= 35.31467 cubic feet
1 litre	= 0.26417 US gallons
1 barrel = 42 US gallons	= 0.15899 cubic meters
1 cubic foot	= 0.028317 cubic meters

Example:

A turbine meter produces 860 pulses for 1 US gallon. How many pulses from this same turbine equals 1 cubic meter? 1 US gallon = 0.0037854 cubic meters.

$$\text{Pulses per cubic meter} = \frac{860 \text{ K Factor of Turbine Meter/usually in US Gallons}}{0.0037854 \text{ (from table above)}} = 227188.67$$

227,188.7 would be the K factor entered for this particular turbine if the Flo Pro 9100 was to indicate total flow in cubic meters.

Note: This is an example only! Use the K factor supplied with your turbine and the appropriate conversion for the measurement you require. In most cases the K factor supplied with the turbine meter is in Pulses per US Gallon.

3.6.3 10 Point Linearization Programming

The 10 Point Linearization feature enables the Flo Pro 9100 to compensate for the non-linearity of a flow meter over its specified operating flow rate range. Typically, the K Factor that equals one volume unit of flow changes with flow rate. For example, the K Factor that equals one barrel at 50% flow, is not the K Factor that would equal one barrel at 10% flow. The linearization feature enables the Flo Pro 9100 to use the correct K Factor for the current flow rate. This results in increased accuracy of the Accumulated Total and Flow Rate.

Ten Point Linearization is achieved by programming up to 10 K Factors that correlate to the flow meter's frequency output at a specified flow rate. In order to do this each flow meter in question must be proved at up to 10 appropriate flow meter frequency points. This service is usually provided by flow meter vendors at an extra cost. The following chart is for a 1" flow meter that has been proved at ten different meter frequencies. This chart is an *example only!*

Meter Frequency (Hz)	Meter Flow Rate (GPM)	Meter K Factor (Pulses/GAL)	Meter Temp (°F)
F10 = 796	50.20	952.16	70.43
F9 = 710	44.73	952.34	70.82
F8 = 656	41.43	950.86	70.99
F7 = 582	36.71	952.75	71.05
F6 = 486	30.63	953.41	71.12
F5 = 379	23.88	954.46	71.17
F4 = 313	19.67	955.63	71.24
F3 = 246	15.43	957.31	71.26
F2 = 159	9.94	960.12	71.26
F1 = 78	4.92	952.19	71.27

This chart shows how the number of pulses in 1 U.S. gallon changes with the frequency of the meter.

The Flo Pro 9100, through the PntS parameter, allows the operator to select how many linearization points are used (from 1 to 10 points).

Note: The more points used for linearization, the more accurate the readings will be.

3.6.4 Enabling 10 Point Linearization

Press the MENU key until the message “L i n E A r x” (x will be either Y or n)



appears on the display. Press the SELECT DIGIT key and the current setting will start blinking. Use the CHNG DIGIT key to select either Y (enabled) or n (disabled). Pressing the MENU Key again will save this setting.

3.6.5 Setting the Number of Points

The number of linearization points may be set from 1 to 10 by pressing the menu



key until the “P n t S x” message (where x is the current number of points in use) appears on the display. Next, use the SELECT DIGIT and CHNG DIGIT keys to set the desired number of points. Press the MENU key again to save the current setting.

Note: More linearization points will give higher accuracy.

3.6.6 Default K Factor

Ensure the unit is programmed with a default K Factor. This value should be approximately the average of the K Factors used for linearization. See the K Factor and Engineering Units Section of this manual to program this.

3.6.7 Linear Frequencies and Linear K Factors

Press the K FACTOR key until the first linearization frequency appears on the

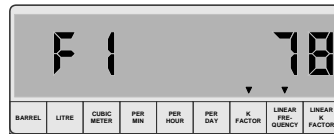

display. This is indicated by “F 1 XX” (where xx is the current value for the first linearization frequency). The K FACTOR and LINEAR FREQUENCY indicators will also appear on the display. Use the SELECT DIGIT and CHNG DIGIT keys to set the first linearization frequency to the desired value.



All frequencies for linearization must be entered in ascending order. F1 must be the lowest frequency, F2 must be a higher frequency, etc.

Press the K FACTOR key again to save the frequency and display the current K



FACTOR for that frequency. The LINEAR K FACTOR indicator will come on. Use the SELECT DIGIT and CHNG DIGIT keys to set the K Factor to the desired value. For best results, the K factors should all be programmed with the same number of decimal positions. Using the maximum number of decimal positions possible will increase accuracy.

The *difference* between one K factor and the next must not exceed the following values:

- If no decimal point is used the *difference* must not exceed 400 000.
- If one decimal point (0.0) is used the *difference* must not exceed 40 000.
- If two decimal places (0.00) are used the *difference* must not exceed 4000.

Pressing the K FACTOR key again will save the displayed K Factor and show the next frequency for programming (F2, F3, etc.). Repeat these steps until all linearization frequencies and K factors have been programmed. After the last linearization parameter has been programmed, pressing the K FACTOR key will display the message “L I n d o n E” to indicate that all of the points have been

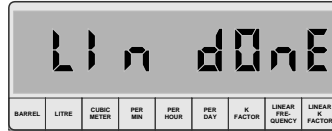

entered.

If the Frequencies were not entered in ascending order, or the difference between K Factors was too great the Flo Pro 9100 will display CFg Err2 to indicate a problem. If this happens the error must be corrected, or linearization disabled before the unit will operate properly.

3.6.8 Rate Update Interval

The Rate Update Interval time determines how often the displayed flow rate is updated. The Rate Update Interval is adjustable from two (2) to twenty (20) seconds. For slow or fluctuating flow rates a longer Rate Update Interval is suggested. Longer Rate Update Intervals will give more accurate flow rates on the display. The default setting is 2 seconds.

Note: Flow rate is not updated when the FLO PRO 9100 is in the power saving mode.

Press the MENU key until “UP d A t E X” is displayed (where x is the current



update interval in seconds). Use the SELECT DIGIT and CHNG DIGIT keys to set the update interval to the desired value. Pressing the MENU key again will save the displayed value.

3.6.9 Accumulated Total Decimal Point Position

Three decimal point positions are provided to allow the accumulated total to be displayed in 0.1, 0.01 and 0.001 units of flow. The K Factor used must be the K Factor that represents one volume unit of flow. The Flo Pro 9100 automatically calculates the proper division each time the DECIMAL POINT key is pressed. For example: if 870 pulses equals 1 US gallon and it is desired that the accumulated total be displayed in hundredths of a gallon, the K Factor that must be used is 870 and the decimal point should be set to the 0.01 position. Each time the DECIMAL POINT key is pressed the decimal point will move one position to the left (from 0.1 to 0.01 to 0.001).

Note: When changing the decimal position from 0.001 to no decimal point, the portion of the value to the right of the decimal point will be lost.



Do not change the decimal point position while the unit is operating. This could result in incorrect accumulated flow totals.

3.6.10 On Time (Active Time)

The On Time setting is the length of time, after the last key press that the Flo Pro 9100 will remain in the Active Mode (Please refer to the **Operation** section of this manual). This parameter is adjustable from 1 to 99 minutes. The On Time default is 2 minutes.

To adjust the On Time, ensure the unit is displaying Total, then press the SELECT DIGIT key followed by the TOTAL / RATE key and hold both keys until the “0 † X” message appears on the display (where x is the current On Time



then

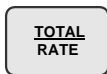

setting). Use the SELECT DIGIT and CHNG DIGIT keys to set the On Time to the desired value. Press the TOTAL / RATE key to save the displayed value and return to the Total display. **THE “d0” INDICATES THAT THE DISPLAY WILL BE SHUT OFF AFTER THE ON TIME HAS EXPIRED. A “d1” INDICATES THE DISPLAY WILL STAY ON.** This is user selectable in the same menu using the Select Digit and Change Digit keys.



Battery life specifications are based on this time being set to 1 or 2 minutes. By selecting a value 0 the unit will stay in Active Mode permanently, this will reduce the battery life.

3.6.11 Accumulated Total Reset Enable

The Flo Pro 9100 can be configured to enable or disable front key pad reset of the accumulated total (please refer to the Operation section of this manual). The default setting is enabled.

To change the Reset Enable parameter, ensure the unit is displaying Total, then press the SELECT DIGIT key followed by the RATE TIME BASE key and hold

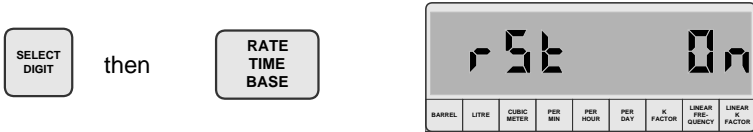

both keys until the “r S t X” message appears on the display (where x is the current Reset Enable setting). Use the CHNG DIGIT key to set the Reset Enable to either On or OFF. Press the RATE TIME BASE key to save the displayed value and return to the Total display.

3.6.12 K Factored Pulse Output Multiplier (optional)

The Flo Pro 9100 provides two types of pulse output: Raw Pulse, which is generated from the turbine input and can be scaled through the use of the Prescale jumpers (see the Pulse Output Connection section of this manual for more information); and K Factored, which is generated from the calculated total and can be scaled through programming. The Pulse Output Selection Jumper (J9) is used to select between the two types of output (set to Batch for K Factored Pulse Output).

Note: When using the K Factored Pulse Output, the Prescale Jumpers will still affect the Pulse output. The Prescale Jumper should be set to /1 if the Pulse Output Multiplier is set below 1000.

To enable the K factored pulse output, ensure that the Pulse Output Selection Jumper (J9) is set to Batch and the Prescale Jumper is set to /1. Press the MENU key until “P O u t X” is displayed (where x is the current Pulse Output Multiplier). Use the SELECT DIGIT and CHANGE DIGIT keys to adjust the Pulse Output Multiplier to the desired value. The Pulse Output Multiplier is based on the far right digit of the displayed value, regardless of the current decimal position. This means that a Pulse Output Multiplier of 1 will give one output pulse for each time the rightmost digit is incremented, a Multiplier of 10 will give one pulse for

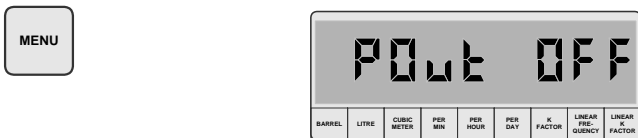

each 10 times the rightmost digit is incremented (or one pulse each time the second from the right digit is incremented). The Pulse Output Multiplier can be set to 1, 10, 100, or 1000.

The Prescale Jumpers can be used to further increase the number of units per pulse out however the Prescale Jumper should not be used until the Pulse Output Multiplier is set to 1000. The following charts show the relationship between the decimal position, Pulse Output Multiplier, and the Prescale Jumpers.

For the following charts use this key:

Multiplier = Pulse Output Multiplier Setting

Jumper = Prescale Jumper Setting

Units/Pulse = Number of flow units represented by one output pulse

0. = Representation of displayed decimal location

* = Indication of the digit which will cause an output pulse when incremented

No Accumulated Total Decimal Point

1	0	0	0	0	0	0	0.	Multiplier	Jumper	Units/Pulse
							*	1	/1	1
						*		10	/1	10
				*				100	/1	100
			*					1000	/1	1000
		*						1000	/10	10 000
	*							1000	/100	100 000
	*							1000	/1000	1 000 000

Accumulated Total Decimal Point = 0.1

1	0	0	0	0	0	0.	0	Multiplier	Jumper	Units/Pulse
							*	1	/1	0.1
						*		10	/1	1.0
				*				100	/1	10.0
			*					1000	/1	100.0
		*						1000	/10	1000.0
	*							1000	/100	10 000.0
	*							1000	/1000	100 000.0

Accumulated Total Decimal Point = 0.01

1	0	0	0	0	0.	0	0	Multiplier	Jumper	Units/Pulse
							*	1	/1	0.01
							*	10	/1	0.10
					*			100	/1	1.00
				*				1000	/1	10.00
			*					1000	/10	100.00
		*						1000	/100	1000.00
	*							1000	/1000	10 000.00

Accumulated Total Decimal Point = 0.001

1	0	0	0	0.	0	0	0	Multiplier	Jumper	Units/Pulse
							*	1	/1	0.001
							*	10	/1	0.010
					*			100	/1	0.100
				*				1000	/1	1.000
			*					1000	/10	10.000
		*						1000	/100	100.000
	*							1000	/1000	1000.000

The maximum allowable pulse output frequency when using the Pulse Output Multiplier is 60Hz. If the 60Hz limit is exceeded the Flo Pro will display Pout Er1 to indicate the problem. To clear this message, press any key. If the error reoccurs the message will reappear. If this message is appearing frequently, the Pulse Output Multiplier should be adjusted to a higher value to decrease the frequency of the output.

To determine whether or not the current setting will be greater than 60Hz use the following formula:

$$\frac{1}{\text{Units/Pulse (determined from Charts) x Maximum flow rate (in units per second)}}$$

If the result is greater than 60 the setting will need to be changed to prevent errors at higher flow rates.

For example: A Flo Pro is being used with a 1" turbine meter with a flow range of 5-50Gallons/Minute. The Accumulated Decimal Point Position is set to 0.01. The Multiplier is set to 10. The prescale jumper is set to /1.

From the Charts we see that the Units/Pulse at these settings is 0.10. Will the output be greater than 60Hz?

$$\frac{50 \text{ Gallons/Minute}}{60 \text{ Seconds/Minute}} = 0.833 \text{ Gallons/Second}$$
$$\frac{1}{0.10 \text{ Units/Pulse} \times 0.833 \text{ Gallons/Second}} = 12\text{Hz}$$

12Hz is less than 60Hz so these settings will not give errors at higher frequencies. If the value had been greater than 60 then the settings would have to be adjusted.

Note: The K Factored Pulse Output is based on the value displayed by the Flo Pro 9100. If the displayed value is being calculated using 10 point linearization the pulse output will also be affected by it.

4 Troubleshooting

Problem	Possible Solution
Incorrect Flow Rate and/or Accumulated Total	<ul style="list-style-type: none"> * Ensure correct K Factor is programmed. * Ensure flow meter is installed correctly. * Ensure pulse output is connected properly. * Incorrect Flow Meter for application.
Incorrect Accumulated Total when using 0.1, 0.01, or 0.001 decimal point positions	<ul style="list-style-type: none"> * Ensure the K Factor Programmed into the unit is equal to 1 unit of flow. (the Flo Pro 9100 automatically calculates the decimal positions)
Unit does not register any Accumulated Totals or Flow Rates	<ul style="list-style-type: none"> * Ensure magnetic pickup cable is properly connected and not broken. * Check for faulty magnetic pickup. * Flow Meter may be faulty.
Decimal point is blinking when updating total	<ul style="list-style-type: none"> * This is normal when the unit is in Power Save Mode (see Modes of Operation section of this manual)
Unit will not allow me to change parameters	<ul style="list-style-type: none"> * PROG switch is in the Disable position. Set the PROG switch to Enable to edit parameters.
CFg Err message is displayed	<ul style="list-style-type: none"> * Error in the 10 Point Linearization setup. * Ensure that all linearization parameters are set properly (see Programming section of this manual).
PLC or RTU does not appear to be processing output pulses from the Flo Pro 9100	<ul style="list-style-type: none"> * Ensure the Pulse output is wired correctly. * The pulses may be at too high frequency for the RTU or PLC. Set the Prescale jumper to a different setting (see the installation section of this manual).
Unit does not power up correctly when the battery pack is connected	<ul style="list-style-type: none"> * Unplug the battery pack wait ten seconds then try again. * Battery pack may be discharged. Try a new battery pack.
After setting up for 10 point linearization, unit show CFg Err2	<ul style="list-style-type: none"> * Ensure the linearization frequencies are programmed in ascending order. * Ensure that the differences between K factors do not exceed specified values.
The unit displays Pout Er1	<ul style="list-style-type: none"> * The K Factored Pulse Output has exceeded 60Hz. * Press any key to return to normal operation. * If the problem persists, set the Pulse Output Multiplier to a higher value.

